



# Split Cath® LONG-TERM HEMODIALYSIS

## INSTRUCTIONS FOR USE

### INDICATIONS FOR USE:

- The Medcomp® Pediatric Split Cath® is indicated for use in attaining Long-Term vascular access for Hemodialysis and Apheresis and in pediatric, adolescent, and adult patients as determined by the prescribing physician.
- It may be inserted percutaneously and is primarily placed in the internal jugular vein.
- Alternate insertion sites include the subclavian and femoral vein.

### CONTRAINDICATIONS:

- This catheter is intended for Long-Term vascular access only and should not be used for any purpose other than indicated in these instructions.

### DESCRIPTION:

- The versatility of the Pediatric Split Cath® allows the split lumens to form two free floating lumens to help eliminate catheter occlusion by the vessel.
- The Pediatric Split Cath® is manufactured from soft radiopaque polyurethane material which provides increased patient comfort while providing excellent biocompatibility.

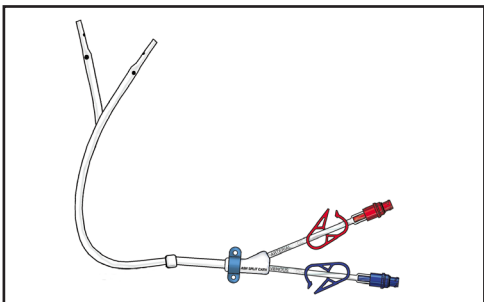

### POTENTIAL COMPLICATIONS:

- Air Embolus
- Bacteremia
- Brachial Plexus Injury
- Cardiac Arrhythmia
- Cardiac Tamponade
- Central Venous Thrombosis
- Endocarditis
- Exit Site Infection
- Exsanguination
- Femoral Artery Bleed
- Femoral Nerve Damage
- Hematoma
- Hemorrhage
- Hemothorax
- Inferior Vena Cava Puncture
- Laceration of the Vessel
- Lumen Thrombosis
- Mediastinal Injury
- Perforation of the Vessel
- Pleural Injury

- Pneumothorax
- Retroperitoneal Bleed
- Right Atrial Puncture
- Septicemia
- Subclavian Artery Puncture
- Subcutaneous Hematoma
- Superior Vena Cava Puncture
- Thoracic Duct Laceration
- Tunnel Infection
- Vascular Thrombosis
- Venous Stenosis

- Before attempting the insertion, ensure that you are familiar with the potential complications and their emergency treatment should any of them occur.

### WARNINGS:

- In the rare event that a hub or connector separates from any component during insertion or use, take all necessary steps and precautions to prevent blood loss or air embolism and remove catheter.
- Do not advance the guidewire or catheter if unusual resistance is encountered.
- Do not insert or withdraw the guidewire forcibly from any component. The wire may break or unravel. If the guidewire becomes damaged, the introducer needle or Vasco-Sheath® introducer and guidewire must be removed together.

- Federal Law (USA) restricts the device to sale by or on the order of a physician.

- This catheter is for Single Use Only.

- Do not resterilize the catheter or accessories by any method.

- Re-use may lead to infection or illness/injury.

- The manufacturer shall not be liable for any damages caused by re-use or resterilization of this catheter or accessories.

- Contents sterile and non-pyrogenic in unopened, undamaged package. STERILIZED BY ETHYLENE OXIDE

STERILE EO

- Do not use catheter or accessories if package is opened or damaged.

- Do not use catheter or accessories if any sign of product damage is visible.

- End caps are not intended to be punctured with a needle.

### CATHETER PRECAUTIONS:

- Do not use sharp instruments near the extension tubing or catheter lumen.

- Do not use scissors to remove dressing.

- Catheter will be damaged if clamps other than what is provided with this kit are used.

- Clamping of the tubing repeatedly in the same location may weaken tubing. Avoid

clamping near the luers and hub of the catheter.

- Examine catheter lumen and extensions before and after each treatment for damage.

- To prevent accidents, assure the security of all caps and bloodline connections prior to and between treatments.

- Use only Luer Lock (threaded) Connectors with this catheter.

- Repeated over tightening of bloodlines, syringes, and caps will reduce connector life and could lead to potential connector failure.

### INSERTION SITES:

**Warning:** Physician discretion is strongly advised when inserting this catheter in patients who are unable to take or hold a deep breath.

- The patient should be in a modified Trendelenburg position, with the upper chest exposed and the head turned slightly to the side opposite the insertion area. A small rolled towel may be inserted between the shoulder blades to facilitate the extension of the chest area.

#### Internal Jugular Vein

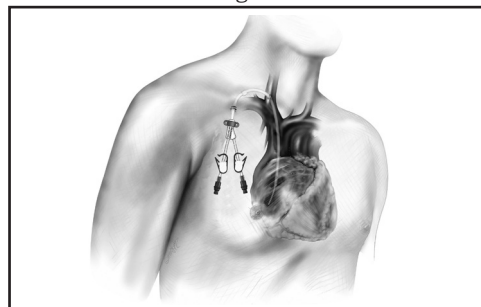

- Have patient lift his/her head from the bed to define the sternomastoid muscle. Catheterization will be performed at the apex of a triangle formed between the two heads of the sternomastoid muscle. The apex should be approximately three finger breadths above the clavicle. The carotid artery should be palpated medial to the point of catheter insertion.

#### Subclavian Vein

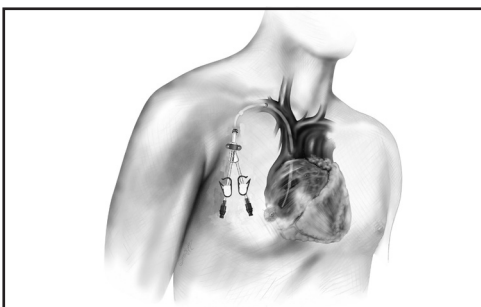

- Note the position of the subclavian vein, which is posterior to the clavicle, superior to the first rib, and anterior to the subclavian artery. (At a point just lateral to the angle made by the clavicle and the first rib.)

**Warning:** Patients requiring ventilator support are at increased risk of pneumothorax during subclavian vein cannulation, which may cause complications.

**Warning:** Extended use of the subclavian vein may be associated with subclavian vein stenosis.

#### Tip Placement

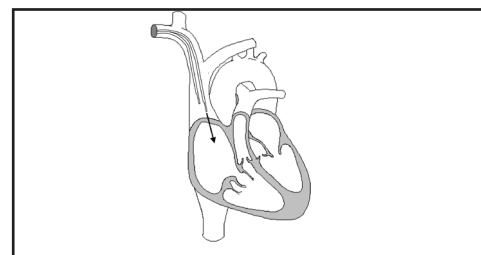

#### Femoral Vein

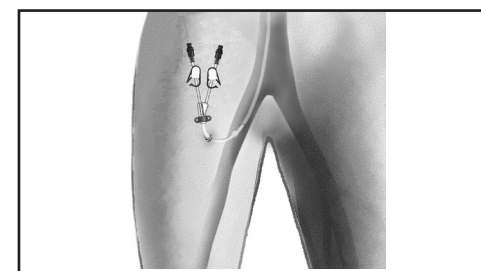

- The patient should lie completely on his/her back. Both femoral arteries should be palpated for site selection and consequence assessment. The knee on the same side of the insertion site should be flexed and the thigh abducted. Place the foot across the opposite leg. The femoral vein is then posterior/medial to the artery.

**Note:** The incidence of infection may be increased with femoral vein insertion.

- Confirm final position of catheter with chest x-ray. Routine x-ray should always follow the initial insertion of this catheter to confirm proper tip placement prior to use.

- Femoral catheter tip placement is recommended at the junction of the iliac vein and the inferior vena cava.<sup>1</sup>

### DIRECTIONS FOR SELDINGER INSERTION

- Read instructions carefully before using this device. The catheter should be inserted, manipulated, and removed by a qualified, licensed physician or other qualified health care professional under the direction of a physician.

- The medical techniques and procedures described in these instructions for use do not represent all medically acceptable protocols, nor are they intended as a substitute for the physician's experience and judgment in treating any specific patient.

- Use standard hospital protocols when applicable.

- Strict aseptic technique must be used during insertion, maintenance, and catheter removal procedures. Provide a sterile operative field. The Operating Room is the preferred location for catheter placement. Use sterile drapes, instruments, and accessories. Shave the skin above and below the insertion site. Perform surgical scrub. Wear gown, cap, gloves, and mask. Have patient wear mask.

- The selection of the appropriate catheter length is at the sole discretion of the physician. To achieve proper tip placement, proper catheter length selection is important. Routine x-ray should always follow the initial insertion of this catheter to confirm proper placement prior to use.

- Administer sufficient local anesthetic to completely anesthetize the insertion site.

- Make a small incision at the exit site on the chest wall approximately 8-10cm below the clavicle. Make a second incision above and parallel to the first, at the insertion site. Make the incision at the exit site wide enough to accommodate the cuff, approximately 1cm.

- Use blunt dissection to create the subcutaneous tunnel opening. Attach the catheter to the trocar. Slide catheter tunneling sleeve over the catheter making certain that the sleeve covers the arterial holes of the catheter. Insert the trocar into the exit site and create a short subcutaneous tunnel. Do not tunnel through muscle. The tunnel should be made with care in order to prevent damage to surrounding vessels.

- For Femoral Vein Insertion: Create subcutaneous tunnel with the catheter exit site in the pelvic region.

**Warning:** Do not over-expand subcutaneous tissue during tunneling. Over-expansion may delay/prevent cuff in-growth.

- Lead catheter into the tunnel gently. Do not pull or tug the catheter tubing. If resistance is encountered, further blunt dissection may facilitate insertion. Remove the catheter from the trocar with a slight twisting motion to avoid damage to the catheter.

**Caution:** Do not pull tunneler out at an angle. Keep tunneler straight to prevent damage to catheter tip.

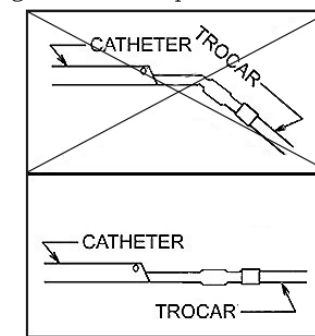

- Split the arterial and venous lumens by grasping the distal ends and gently pull apart the lumens to the point printed "DO NOT SPLIT BEYOND THIS POINT".

**Warning: Splitting the lumens beyond this point may result in excess tunnel bleeding, infection, or damage to the catheter lumens.**

**Note:** A tunnel with a wide gentle arc lessens the risk of kinking. The tunnel should be short enough to keep the Y-hub of the catheter from entering the exit site, yet long enough to keep the cuff 2cm (minimum) from the skin opening.

- Irrigate catheter with saline, then clamp catheter extensions to assure that saline is not inadvertently drained from lumens. Use clamps provided.

- Insert the introducer needle with attached syringe, or into the target vein. Aspirate to insure proper placement.

- Remove the syringe, and place thumb over the end of the needle to prevent blood loss or air embolism. Draw flexible end of guidewire back into advancer so that only the end of the guidewire is visible. Insert advancer's distal end into the needle hub. Advance guidewire with forward motion into and past the needle hub into the target vein.

**Caution:** The length of the wire inserted is determined by the size of the patient. Monitor patient for arrhythmia throughout this procedure. The patient should be placed on a cardiac monitor during this procedure. Cardiac arrhythmias may result if guidewire is allowed to pass into the right atrium. The guidewire should be held securely during this procedure.

- Remove needle, leaving guidewire in the target vein. Enlarge cutaneous puncture site with scalpel.

- Thread dilator(s) over guidewire into the vessel (a slight twisting motion may be used). Remove dilator(s) when vessel is sufficiently dilated, leaving guidewire in place.

**Caution:** Insufficient tissue dilation can cause compression of the catheter lumen against the guidewire causing difficulty in the insertion and removal of the guidewire from the catheter. This can lead to bending of the guidewire.

**Caution:** Do not leave vessel dilator(s) in place as an indwelling catheter to avoid possible vessel wall perforation.

- Thread Vasco-Sheath® introducer over the proximal end of the guidewire. Once the Vasco-Sheath® introducer is in the target vein, remove the guidewire leaving the sheath and dilator in position.

**Caution:** DO NOT bend the sheath/dilator during insertion as bending will cause the sheath to prematurely tear. Hold sheath/

dilator close to the tip (approximately 3cm from tip) when initially inserting through the skin surface. To progress the sheath/dilator towards the vein, regrasp the sheath/dilator a few centimeters (approximately 5cm) above the original grasp location and push down on the sheath/dilator. Repeat procedure until sheath/dilator is fully inserted.

**Note:** For alternate sheath method, see Micro Puncture Insertion Method Section.

**Caution:** Never leave sheath in place as an indwelling catheter. Damage to the vein will occur.

14. Install end cap over dilator opening to prevent blood loss or air embolism.

**Caution:** Do not clamp the dual lumen portion of the catheter. Clamp only the extensions. Do not use serrated forceps; use only the in-line clamps provided.

15. Remove dilator and end cap from sheath.

16. Insert distal tips of catheter into and through the sheath until catheter tips are correctly positioned in the target vein.

17. Remove the tear-away sheath by slowly pulling it out of the vessel while simultaneously splitting the sheath by grasping the tabs and pulling them apart (a slight twisting motion may be helpful).

**Caution:** Do not pull apart the portion of the sheath that remains in the vessel. To avoid vessel damage, pull back the sheath as far as possible and tear the sheath only a few centimeters at a time.

18. Make any adjustments to catheter under fluoroscopy. The distal venous tip should be positioned at the level of the caval atrial junction or into the right atrium to ensure optimal blood flow.

**Note:** Femoral catheter tip placement is recommended at the junction of the iliac vein and the inferior vena cava.<sup>1</sup>

19. Attach syringes to both extensions and open clamps. Blood should aspirate easily from both arterial and venous sides. If either side exhibits excessive resistance to blood aspiration, the catheter may need to be rotated or repositioned to obtain adequate blood flows.

20. Once adequate aspiration has been achieved, both lumens should be irrigated with saline filled syringes using quick bolus technique. Assure that extension clamps are open during irrigation procedure.

21. Close the extension clamps, remove the syringes, and place an end cap on each luer lock connector. Avoid air embolism by keeping extension tubing clamped at all times, when not in use and by aspirating then irrigating the catheter with saline prior to each use. With each

change in tubing connections, purge air from the catheter and all connecting tubing and caps.

22. To maintain patency, a heparin lock must be created in both lumens. Refer to hospital heparinization guidelines.

**Caution:** Assure that all air has been aspirated from the catheter and extensions. Failure to do so may result in air embolism.

23. Once the catheter is locked with heparin, close the clamps and install end caps onto the extensions' female luers. Tape end caps between treatments to prevent accidental removal.

24. Confirm proper tip placement with fluoroscopy. The distal venous tip should be positioned at the level of the caval atrial junction or into the right atrium to ensure optimal blood flow (as recommended in current NKF DOQI Guidelines).

**Note:** Femoral catheter tip placement is recommended at the junction of the iliac vein and the inferior vena cava.<sup>1</sup>

**Caution:** Failure to verify catheter placement may result in serious trauma or fatal complications.

#### CATHETER SECUREMENT AND WOUND DRESSING:

25. Suture insertion site closed. Suture the catheter to the skin using the suture wing. Do not suture the catheter tubing.

**Caution:** Care must be taken when using sharp objects or needles in close proximity to catheter lumen. Contact from sharp objects may cause catheter failure.

26. Cover the insertion and exit site with an occlusive dressings.

27. Catheter must be secured/sutured for entire duration of implantation.

28. Record catheter length and catheter lot number on patient's chart.

#### HEMODIALYSIS TREATMENT

- The heparin solution must be removed from each lumen prior to treatment to prevent systemic heparinization of the patient. Aspiration should be based on dialysis unit protocol.

- Before dialysis begins all connections to catheter and extracorporeal circuits should be examined carefully.

- Frequent visual inspection should be conducted to detect leaks to prevent blood loss or air embolism.

- If a leak is found, the catheter should be clamped immediately.

**Caution:** Only clamp catheter with in-line clamps provided.

- Necessary remedial action must be taken prior to the continuation of the dialysis treatment.

**Note:** Excessive blood loss may lead to patient shock.

- Hemodialysis should be performed under physician's instructions.

#### HEPARINIZATION

- If the catheter is not to be used immediately for treatment, follow the suggested catheter patency guidelines.

- To maintain patency between treatments, a heparin lock must be created in each lumen of the catheter.

- Follow hospital protocol for heparin concentration.

- Draw heparin into two syringes, corresponding to the amount designated on the arterial and venous extensions. Assure that the syringes are free of air.

- Remove end caps from the extensions.

- Attach a syringe containing heparin solution to the female luer of each extension.

- Open extensions clamps.

- Aspirate to insure that no air will be forced into the patient.

- Inject heparin into each lumen using quick bolus technique.

**Note:** Each lumen should be completely filled with heparin to ensure effectiveness.

- Close extension clamps.

**Caution:** Extension clamps should only be open for aspiration, flushing, and dialysis treatment.

- Remove syringes.

- Attach a sterile end cap onto the female luers of the extensions.

- In most instances, no further heparin is necessary for 48-72 hours, provided the lumens have not been aspirated or flushed.

#### SITE CARE

- Clean skin around catheter. Chlorhexidine gluconate solutions are recommended; however, iodine-based solutions can also be used.

- Cover the exit site with occlusive dressing and leave extensions, clamps, and caps exposed for access by staff.

- Wound dressings must be kept clean and dry.

**Caution:** Patients must not swim, shower, or soak dressing while bathing.

- If profuse perspiration or accidental wetting compromises adhesion of

dressing, the medical or nursing staff must change the dressing under sterile conditions.

#### CATHETER PERFORMANCE

**Caution:** Always review hospital or unit protocol, potential complications and their treatment, warnings, and precautions prior to undertaking any type of mechanical or chemical intervention in response to catheter performance problems.

**Warning:** Only a physician familiar with the appropriate techniques should attempt the following procedures.

#### INSUFFICIENT FLOWS:

The following may cause insufficient blood flows:

- Occluded arterial holes due to clotting or fibrin sheath.

- Occlusion of the arterial side holes due to contact with vein wall.

Solutions include:

- Chemical intervention utilizing a thrombolytic agent.

#### MANAGEMENT OF ONE-WAY OBSTRUCTIONS:

One-way obstructions exist when a lumen can be flushed easily but blood cannot be aspirated. This is usually caused by tip malposition.

One of the following adjustments may resolve the obstruction:

- Reposition catheter.

- Reposition patient.

- Have patient cough.

- Provided there is no resistance, flush the catheter vigorously with sterile normal saline to try to move the tip away from the vessel wall.

#### INFECTION:

**Caution:** Due to the risk of exposure to HIV (Human Immunodeficiency Virus) or other blood borne pathogens, health care professionals should always use Universal Blood and Body Fluid Precautions in the care of all patients.

- Sterile technique should always be strictly adhered to.

- Clinically recognized infection at a catheter exit site should be treated promptly with the appropriate antibiotic therapy.

- If a fever occurs in a patient with a catheter in place, take a minimum of two blood cultures from a site distant from catheter exit site. If blood culture is positive, the catheter must be removed immediately and the appropriate antibiotic therapy initiated. Wait 48 hours before catheter replacement. Insertion should be made on opposite side of original catheter exit site, if possible.

#### MICRO PUNCTURE INSERTION METHOD

- Once an .018" guidewire has been introduced into the target vein, the 4F sheath dilator should be threaded over the proximal end of the wire and inserted into the target vein.

- When the 4F sheath dilator is located in the target vein, remove the guidewire and dilator one at a time.

- Insert an .038" guidewire into and through the sheath until it is located in the target vein.

- Remove the sheath and continue following directions starting at #13.

#### CATHETER REMOVAL

**Warning:** Only a physician familiar with the appropriate techniques should attempt the following procedures.

**Caution:** Always review hospital or unit protocol, potential complications and their treatment, warnings, and precautions prior to catheter removal.

- Palpate the catheter exit tunnel to locate the cuff.

- Administer sufficient local anesthetic to exit site and cuff location to completely anesthetize the area.

- Cut sutures from suture wing. Follow hospital protocol for removal of skin sutures.

- Make a 2cm incision over the cuff, parallel to the catheter.

- Dissect down to the cuff using blunt and sharp dissection as indicated.

- When visible, grasp cuff with clamp.

- Clamp catheter between the cuff and the insertion site.

- Cut catheter between cuff and exit site. Withdraw internal portion of catheter through the incision in the tunnel.

- Remove remaining section of catheter (i.e. portion in tunnel) through the exit site.

**Caution:** Do not pull distal end of catheter through incision as contamination of wound may occur.

- Apply pressure to proximal tunnel for approximately 10-15 minutes or until bleeding stops.

- Suture incision and apply dressing in a manner to promote optimal healing.

- Check catheter integrity for tears and measure catheter when removed. It must be equal to the length of catheter when it was inserted.

| 10F x 24cm PRESSURE |            |            |            |
|---------------------|------------|------------|------------|
|                     | 100 ml/MIN | 200 ml/MIN | 250 ml/MIN |
| VENOUS              | 60 mmHg    | 140 mmHg   | 190 mmHg   |
| ARTERIAL            | -50 mmHg   | -130 mmHg  | -190 mmHg  |

FLOW RATE TESTING REPRESENTS OPTIMUM LABORATORY CONDITIONS.

#### WARRANTY

**Medcomp® WARRANTS THAT THIS PRODUCT WAS MANUFACTURED ACCORDING TO APPLICABLE STANDARDS AND SPECIFICATIONS. PATIENT CONDITION, CLINICAL TREATMENT, AND PRODUCT MAINTENANCE MAY AFFECT THE PERFORMANCE OF THIS PRODUCT. USE OF THIS PRODUCT SHOULD BE IN ACCORDANCE WITH THE INSTRUCTIONS PROVIDED AND AS DIRECTED BY THE PRESCRIBING PHYSICIAN.**













Because of continuing product improvement, prices, specifications, and model availability are subject to change without notice. Medcomp® reserves the right to modify its products or contents without notice.

*Medcomp®, Split Cath®, and Vascul-Sheath® are registered trademarks of Medical Components, Inc.*

#### References:

- Zaleski GX, Funaki B, Lorenz JM, Garofalo RS, Moscatel MA, Rosenblum JD, Leef JA. Experience with tunneled femoral hemodialysis catheters. *Am J Roentgenol.* 1999 Feb; 172(2):493-6.

#### SYMBOL TABLE

|         |   |   |
|---------|---|---|
| 5.1.1   |    | Manufacturer *                            |
| 5.3.4   |    | Keep Dry *                                |
| 5.4.2   |    | Do Not Re-use *                           |
| 5.6.3   |   | Non-pyrogenic *                           |
| 5.3.2   |  | Keep Away from Sunlight *                 |
| 5.2.3   |  | Sterilized Using Ethylene Oxide *         |
| 5.2.8   |  | Do Not Use if Package is Damaged *        |
| 5.1.4   |  | Use-by Date *                             |
| 5.2.6   |  | Do Not Resterilize *                      |
| 5.1.5   |  | Batch/Lot Number *                        |
| 5.1.6   |  | Catalogue Number *                        |
| 5.4.4   |  | Caution, consult Accompanying Documents * |
| Rx Only |   | Prescription Use Only ***                 |

\*This symbol is in accordance with ISO 15223-1.

\*\*\* FDA guidance Use of Symbols in Labeling.

 Medical Components, Inc.

1499 Delp Drive  
Harleysville, PA 19438 U.S.A.  
Tel: 215-256-4201  
Fax: 215-256-1787  
www.medcompnet.com